

MVHB-500系列

手動閥



規格：

型號	MVHB-500(V)-4TV	MVHB-500(V)-4TV*-SP
	配管口徑代號	15A
配管口徑尺寸	Rc1/2	
方口數	5口	
位置數	2位置	3位置
使用流體	空氣	
使用壓力範圍	0~1.2 MPa	
有效斷面積	41 mm ²	
周圍溫度	-5~+60°C (不凍結)	
重量	519 g	560 g

訂購代號：

MVHB - 500V - 4TVC - SP - G

型號

本體寬度

4 : 4方向

無 : 5口2位
C : 中間位置關閉(5口3位)
P : 中間位置通氣(5口3位)
R : 中間位置排氣(5口3位)

彈簧復歸型

配管口螺牙

無 : Rc牙
G : G牙
NPT : NPT牙

無 : 標準型
V : 直立型

※ V型可搭配 MVSE-500 連座使用 (請參1-34頁)

MVHB-500-4TV

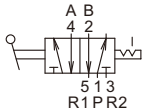

MVHB-500-4TVC

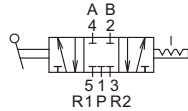

MVHB-500-4TVP

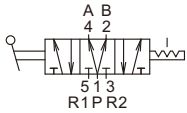

MVHB-500-4TVR

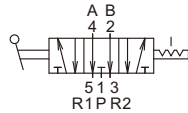

MVHB-500-4TV-SP

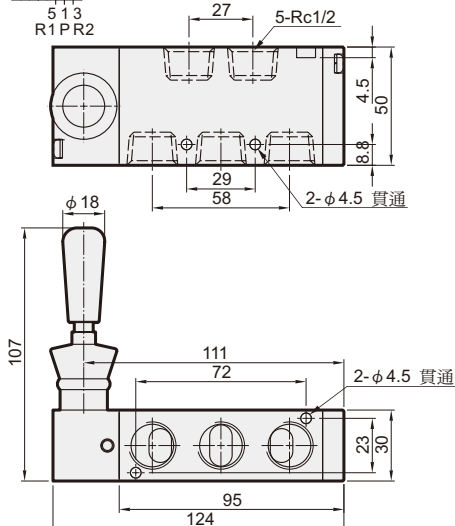
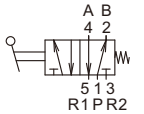

MVHB-500-4TVC-SP

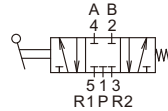

MVHB-500-4TVP-SP

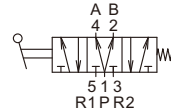

MVHB-500-4TVR-SP

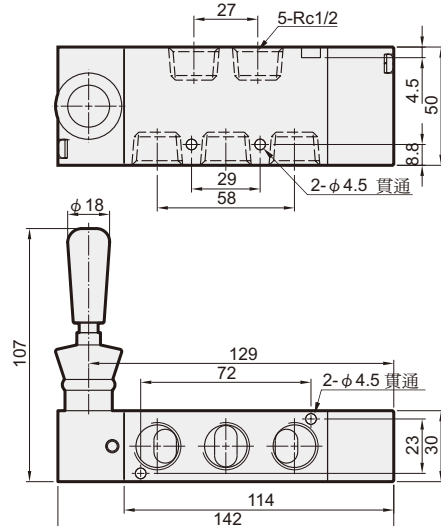
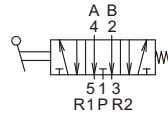

MVHB-500 外觀尺寸

手動閥



MVHB-500V-4TV

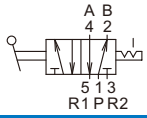

MVHB-500V-4TVC

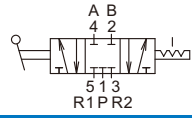

MVHB-500V-4TVP

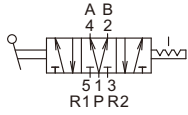

MVHB-500V-4TVR

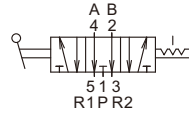

MVHB-500V-4TV-SP

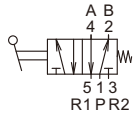

MVHB-500V-4TVC-SP

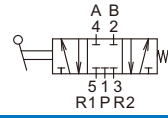

MVHB-500V-4TVP-SP

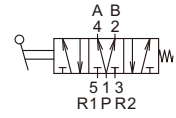

MVHB-500V-4TVR-SP

